

Unterflur-Bodendose UBD 260 aus Chromstahl

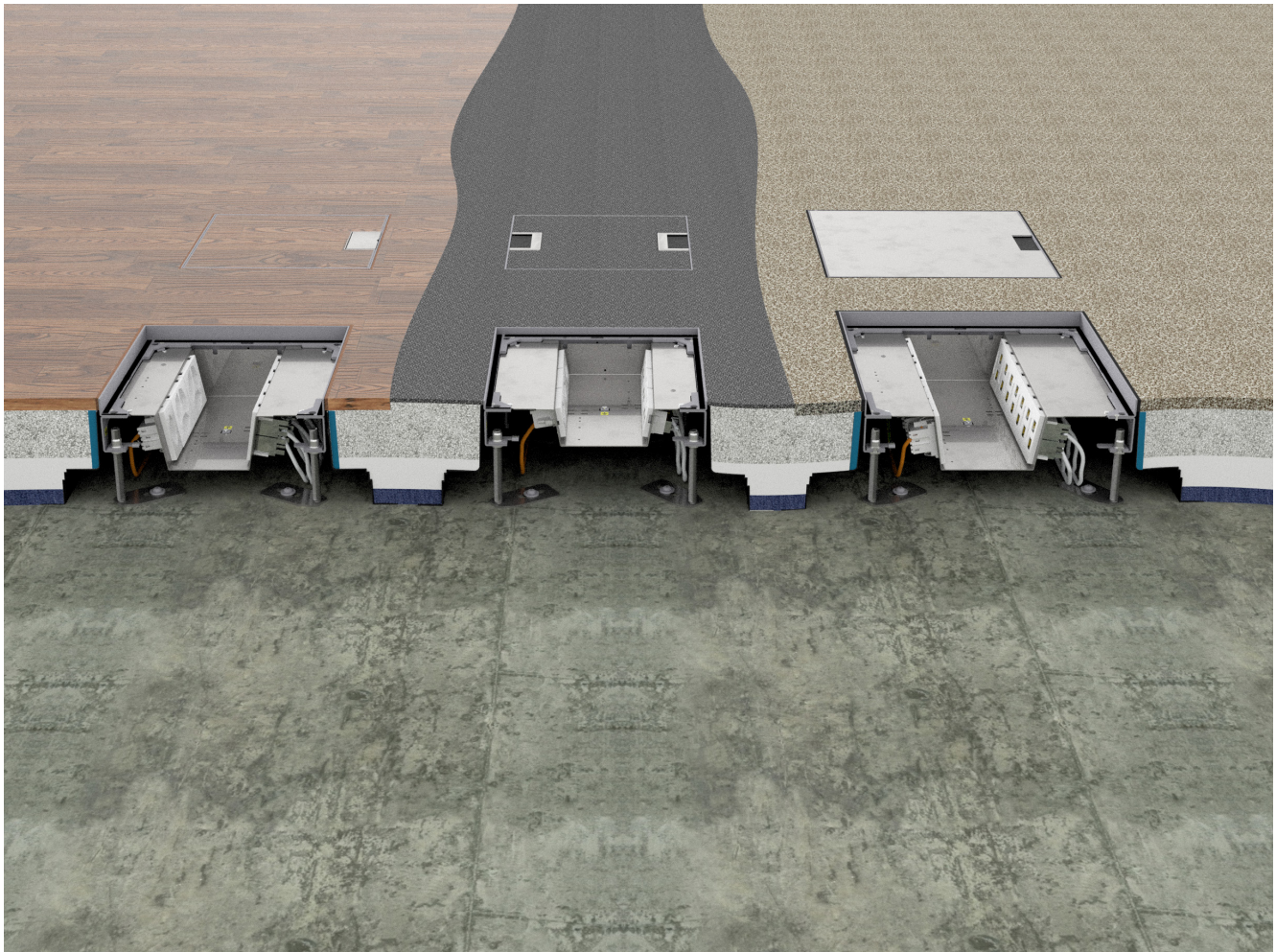

- Minimaler Bodenaufbau ab 62mm mit 5mm Vertiefung im Deckel (Isolation + Unterlagsboden + Bodenbelag)
- Mit innenliegenden Nivellierschrauben
- Rahmen, Deckel mit Kante, Auslass und Steckdoseneinsatz aus Chromstahl
- Unterteil, Deckel flach und Nivellierschrauben aus SVZ (sendzimir-verzinkter Stahl)



	Kunststoff-Einbaubox, schwarz, halogenfrei (siehe Datenblatt) oben: 220/270mm unten: 420/420mm H: 150mm
UBD 260 283	Höhe: 150mm
UBD 260 284	Höhe: 192mm

	Aufstock-Rahmen aus SVZ inkl. Nivellierschrauben zu UBD 260 und 320, UFK bis 375
UBD 260 320	bis 95mm, mit EBB: bis 275mm
UBD 260 321	bis 170mm, mit EBB: bis 350mm

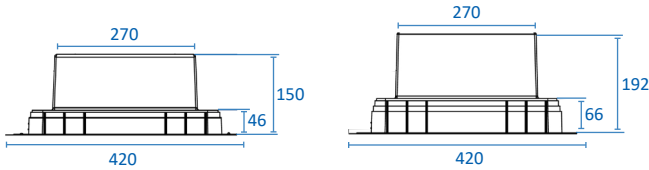

	Trittschall-Unterlage 3mm, für Einbaubox Set à 4 Stk. UBD 001 001
---	--

Details UBD 260 320

Einbaubox Höhe 150mm

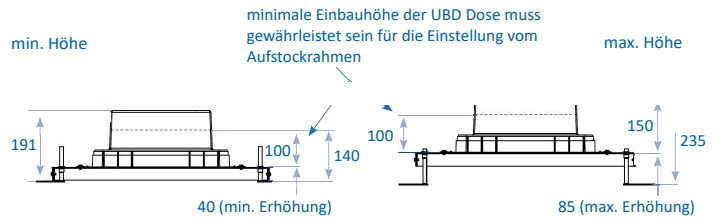

Einbaubox Höhe 192mm

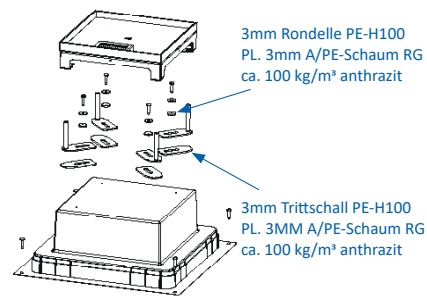
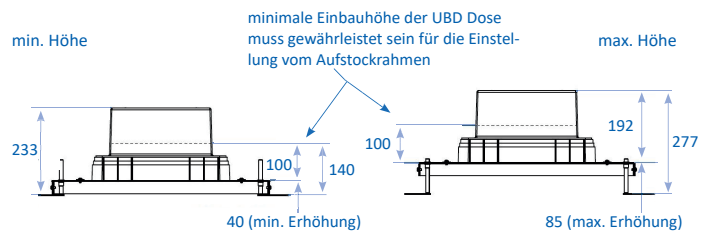

Details UBD 260 321

Einbaubox Höhe 150mm

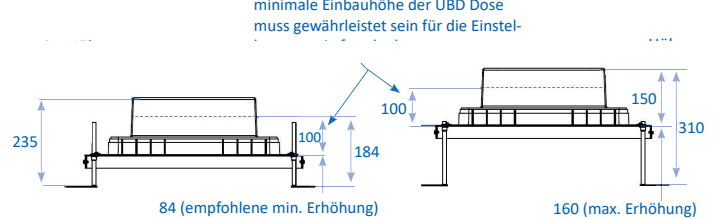

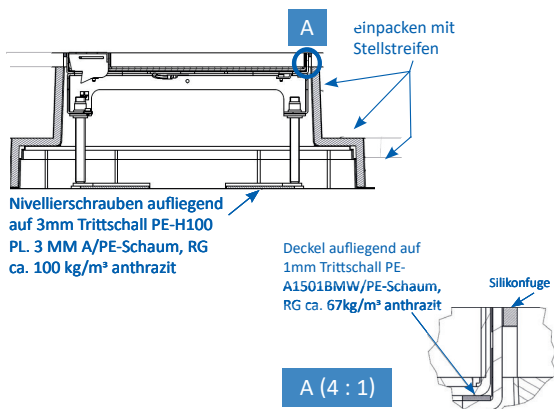
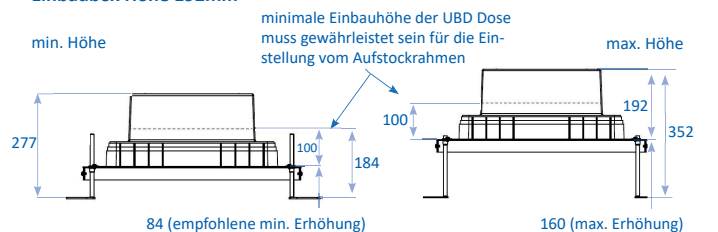

Einbaubox Höhe 192mm





mit 5mm Vertiefung

	Unterflur-Bodendose UBD 260 aus Chromstahl inkl. Deckel, flach (SVZ), ohne Kante, 5mm Vertiefung und 1 Schnurauflass
UBD 262 255	

	Unterflur-Bodendose UBD 260 aus Chromstahl inkl. Deckel, flach (SVZ), ohne Kante, 5mm Vertiefung und 2 Schnurauflässen
UBD 262 257	

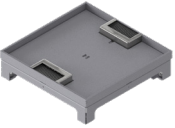
	Unterflur-Bodendose UBD 260 aus Chromstahl inkl. Deckel, flach (SVZ), ohne Kante, 5mm Vertiefung und 1 Bürstenauslass
UBD 262 256	

	Unterflur-Bodendose UBD 260 aus Chromstahl inkl. Deckel, flach (SVZ), ohne Kante, 5mm Vertiefung und 2 Bürstenauslässen
UBD 262 258	

	Unterflur-Bodendose UBD 260 aus Chromstahl inkl. Blinddeckel, flach (SVZ), ohne Kante, 5mm Vertiefung
UBD 262 259	

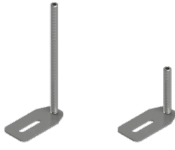
	Nivellierschrauben, Set à 4 Stk.
	Nivellierbereich von Roh- bis Fertigboden
UBD 002 045	62 - 88mm
UBD 002 070	83 - 113mm
UBD 002 095	108 - 138mm
UBD 002 120	1133 - 163mm
UBD 002 145	158 - 188mm
UBD 002 170	183 - 213mm

mit 15mm Vertiefung

	Unterflur-Bodendose UBD 260 aus Chromstahl inkl. Deckel mit Kante, geschlossen, 15mm Vertiefung und 1 Schnurauflass
UBD 260 255	

	Unterflur-Bodendose UBD 260 aus Chromstahl inkl. Deckel mit Kante, geschlossen, 15mm Vertiefung und 2 Schnurauflässen
UBD 260 257	

	Unterflur-Bodendose UBD 260 aus Chromstahl inkl. Deckel mit Kante, geschlossen, 15mm Vertiefung und 1 Bürstenauslass
UBD 260 256	

	Unterflur-Bodendose UBD 260 aus Chromstahl inkl. Deckel mit Kante, geschlossen, 15mm Vertiefung und 2 Bürstenauslässen
UBD 260 258	

	Unterflur-Bodendose UBD 260 aus Chromstahl inkl. Blinddeckel mit Kante, geschlossen, und 15mm Vertiefung
UBD 260 259	

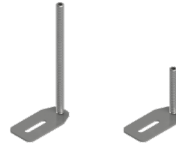
	Nivellierschrauben, Set à 4 Stk.
	Nivellierbereich von Roh- bis Fertigboden
UBD 002 045	72 - 98mm
UBD 002 070	93 - 123mm
UBD 002 095	118 - 148mm
UBD 002 120	143 - 173mm
UBD 002 145	168 - 198mm
UBD 002 170	193 - 223mm



mit 20mm Vertiefung

	Unterflur-Bodendose UBD 260 aus Chromstahl inkl. Deckel mit Kante, geschlossen, 20mm Vertiefung und 1 Schnurauslass
UBD 264 201	

	Unterflur-Bodendose UBD 260 aus Chromstahl inkl. Deckel mit Kante, geschlossen, 20mm Vertiefung und 2 Schnurauslässe
UBD 264 203	

	Unterflur-Bodendose UBD 260 aus Chromstahl inkl. Deckel mit Kante, geschlossen, 20mm Vertiefung und 1 Bürstenauslass
UBD 264 202	

	Unterflur-Bodendose UBD 260 aus Chromstahl inkl. Deckel mit Kante, geschlossen, 20mm Vertiefung und 2 Bürstenauslässe
UBD 264 204	

	Unterflur-Bodendose UBD 260 aus Chromstahl inkl. Blinddeckel mit Kante, geschlossen, und 20mm Vertiefung
UBD 264 205	

mit 25mm Vertiefung

	Unterflur-Bodendose UBD 260 aus Chromstahl inkl. Deckel mit Kante, geschlossen, 25mm Vertiefung und 1 Schnurauslass
UBD 264 251	

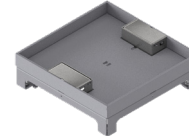
	Unterflur-Bodendose UBD 260 aus Chromstahl inkl. Deckel mit Kante, geschlossen, 25mm Vertiefung und 2 Schnurauslässe
UBD 264 253	

	Unterflur-Bodendose UBD 260 aus Chromstahl inkl. Deckel mit Kante, geschlossen, 25mm Vertiefung und 1 Bürstenauslass
UBD 264 252	

	Unterflur-Bodendose UBD 260 aus Chromstahl inkl. Deckel mit Kante, geschlossen, 25mm Vertiefung und 2 Bürstenauslässe
UBD 264 254	

	Unterflur-Bodendose UBD 260 aus Chromstahl inkl. Blinddeckel mit Kante, geschlossen, und 25mm Vertiefung
UBD 264 255	

	Nivellierschrauben, Set à 4 Stk.
	Nivellierbereich von Roh- bis Fertigboden
UBD 002 045	77 - 103mm
UBD 002 070	98 - 128mm
UBD 002 095	123 - 153mm
UBD 002 120	148 - 178mm
UBD 002 145	173 - 203mm
UBD 002 170	198 - 228mm

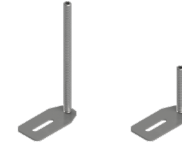
	Nivellierschrauben, Set à 4 Stk.
	Nivellierbereich von Roh- bis Fertigboden
UBD 002 045	82 - 108mm
UBD 002 070	103 - 133mm
UBD 002 095	128 - 158mm
UBD 002 120	153 - 183mm
UBD 002 145	178 - 208mm
UBD 002 170	203 - 233mm

mit 30mm Vertiefung

	Unterflur-Bodendose UBD 260 aus Chromstahl inkl. Deckel mit Kante, geschlossen, 30mm Vertiefung und 1 Schnurauflassung
UBD 264 301	

	Unterflur-Bodendose UBD 260 aus Chromstahl inkl. Deckel mit Kante, geschlossen, 30mm Vertiefung und 2 Schnurauflassungen
UBD 264 303	

	Unterflur-Bodendose UBD 260 aus Chromstahl inkl. Deckel mit Kante, geschlossen, 30mm Vertiefung und 1 Bürstenausslass
UBD 264 302	

	Unterflur-Bodendose UBD 260 aus Chromstahl inkl. Deckel mit Kante, geschlossen, 30mm Vertiefung und 2 Bürstenausslässen
UBD 264 304	

	Unterflur-Bodendose UBD 260 aus Chromstahl inkl. Blinddeckel mit Kante, geschlossen, und 30mm Vertiefung
UBD 264 305	

Chromstahl geschliffen

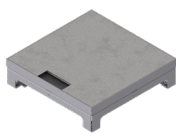
	Unterflur-Bodendose UBD 260 aus Chromstahl inkl. belegtem Deckel mit 1 Bürstenausslass
UBD 260 251	

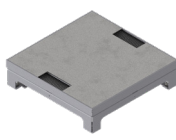
	Unterflur-Bodendose UBD 260 aus Chromstahl inkl. belegtem Deckel mit 2 Bürstenausslässen
UBD 260 252	

	Unterflur-Bodendose UBD 260 aus Chromstahl inkl. belegtem Blinddeckel
UBD 260 253	

	Nivellierschrauben, Set à 4 Stk.
	Nivellierbereich von Roh- bis Fertigboden
UBD 002 045	87 - 113mm
UBD 002 070	108 - 138mm
UBD 002 095	133 - 163mm
UBD 002 120	158 - 188mm
UBD 002 145	183 - 213mm
UBD 002 170	208 - 238mm

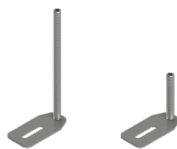
	Nivellierschrauben, Set à 4 Stk.
	Nivellierbereich von Roh- bis Fertigboden
UBD 002 045	72 - 98mm
UBD 002 070	93 - 123mm
UBD 002 095	118 - 148mm
UBD 002 120	143 - 173mm
UBD 002 145	168 - 198mm
UBD 002 170	193 - 223mm

Steckdoseneinsatz für 2x3 FLF ab 62mm, mit 5mm Vertiefung im Deckel

horizontal

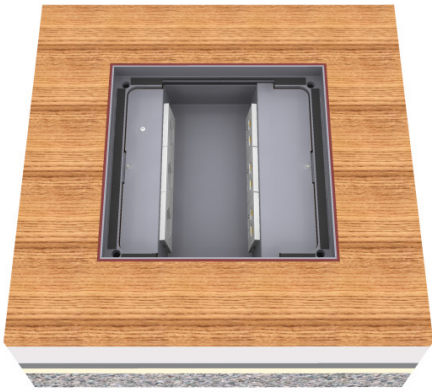

Steckdoseneinsatz für 2x5 FLF ab 84mm, mit 5mm Vertiefung im Deckel

vertikal

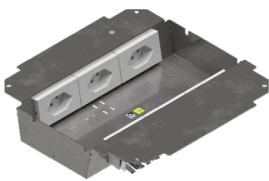
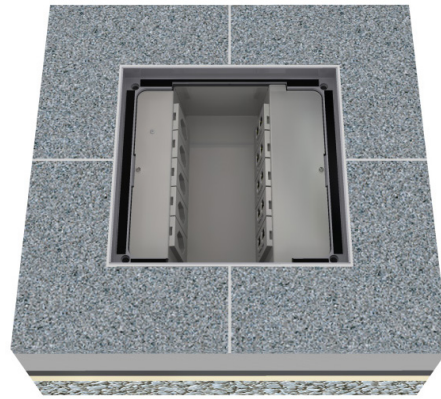

3x 1xT13 weiss

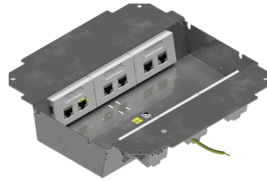

3x 2xRJ45

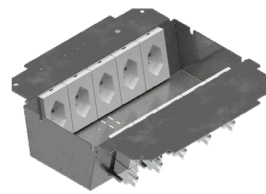

5x 1xT13 weiss

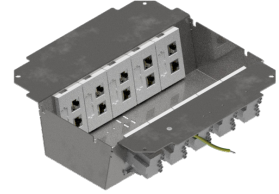

5x 2xRJ45

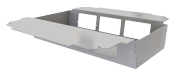

Steckdoseneinsatz für 2x3 FLF inkl.
Erddraht, leer

UBD 260 265

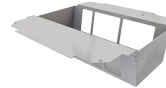

Steckdoseneinsatz für 2x5 FLF
inkl. Erddraht, leer

UBD 260 266

Modul 45x45

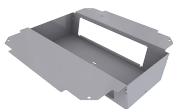

Steckdoseneinsatz mit 2x 4x
45x45-Ausschnitten, leer

UBD 261 290

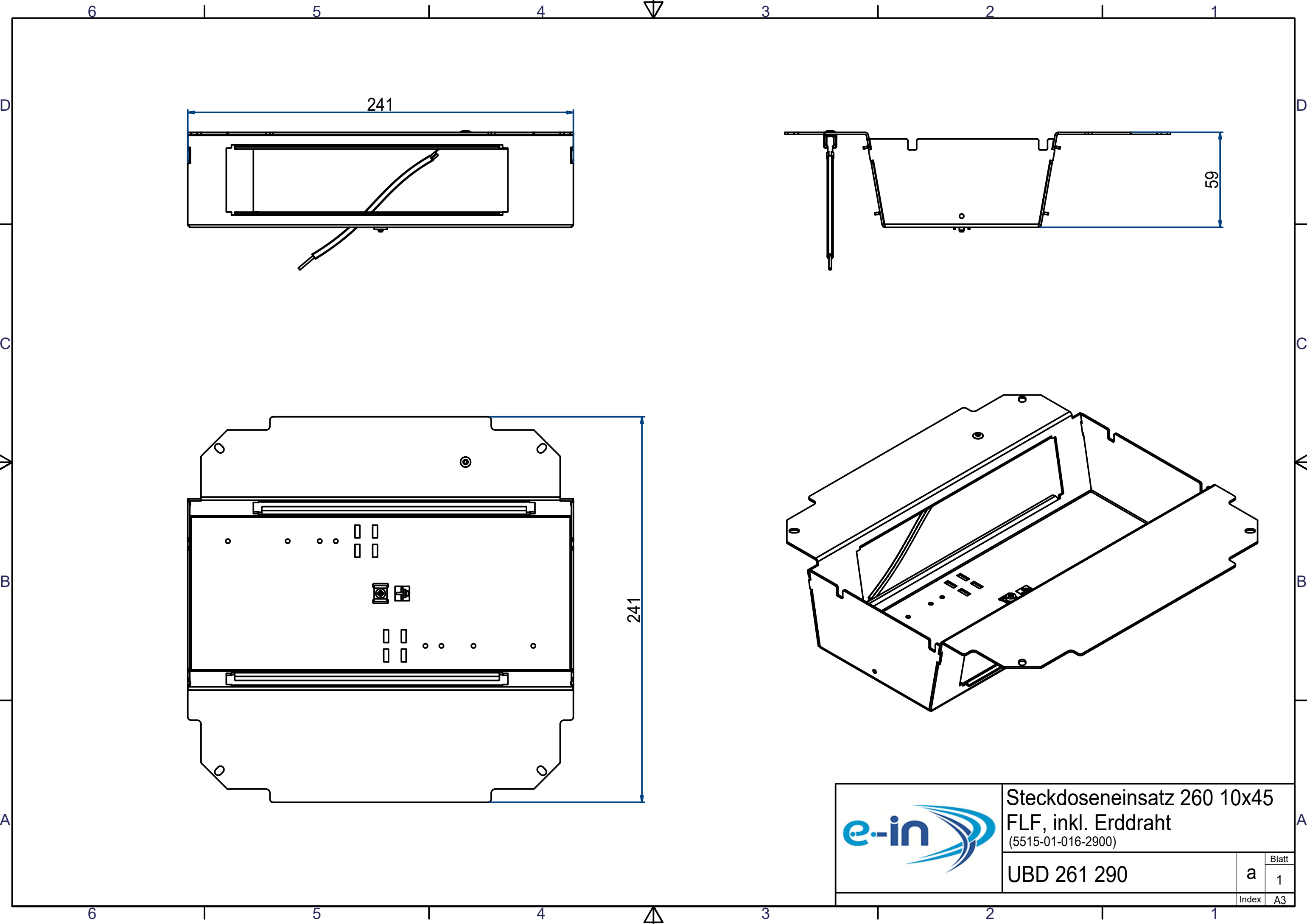

Steckdoseneinsatz 260 10x45
 FLF, inkl. Erddraht
 (5515-01-016-2900)

UBD 261 290

Blatt	1
Index	A3

a

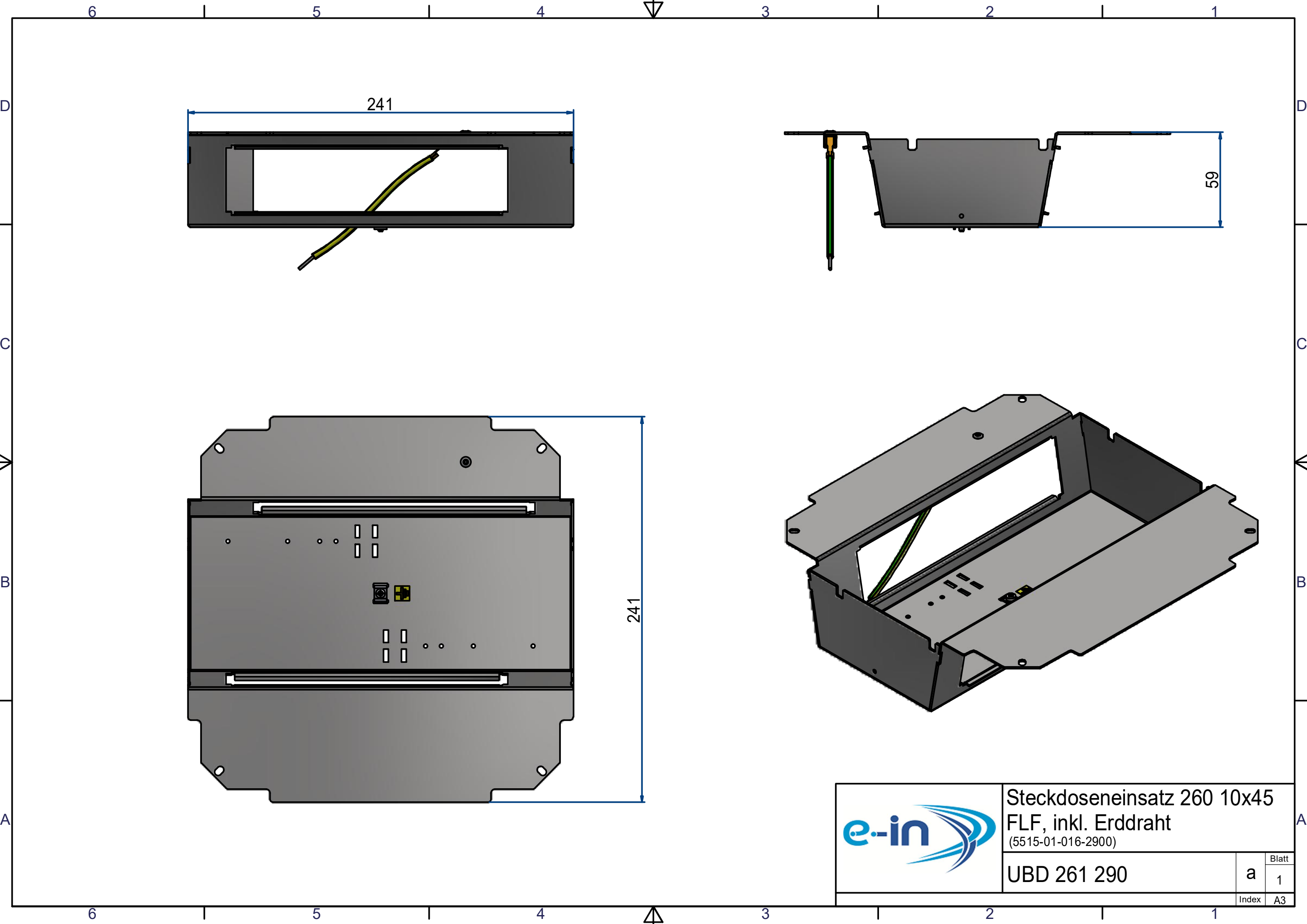







Steckdoseneinsatz 260 10x45
 FLF, inkl. Erddraht
 (5515-01-016-2900)

UBD 261 290

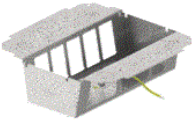
Blatt	1
Index	A3

a

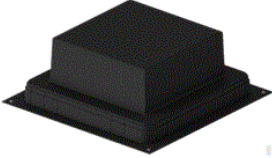
Unterflur-Bodendose UBD 260 & UBD 320

↓ Benötigt		Optional ↓
Steckdoseneinsatz		
Unterflur-Bodendose UBD		
Nivellierschrauben		
		Trittschall-Unterlage (optional)
Kunststoff-Einbaubox		
		Aufstockrahmen (optional)

Anmerkung

1. Etappe: Kunststoff-Einbaubox, Aufstockrahmen
2. Etappe: Unterflur-Bodendose UBD, Nivellierschrauben, Trittschall-Unterlage, Steckdoseneinsatz