

Unterflur-Bodendose UBD 210 aus Chromstahl



- Minimaler Bodenaufbau ab 104mm mit 5mm Vertiefung im Deckel (Isolation + Unterlagsboden + Bodenbelag)
- Mit innenliegenden Nivellierschrauben
- Rahmen, Deckel mit Kante, Auslass und Steckdoseneinsatz aus Chromstahl
- Unterteil, Deckel flach und Nivellierschrauben aus SVZ (sendzimir-verzinkter Stahl)



Kunststoff-Einbaubox, schwarz, halogenfrei (siehe Datenblatt)
oben: 220/220mm
unten: 260/310mm
H: 185mm

UBD 210 250



Aufstock-Rahmen aus SVZ inkl. Nivellierschrauben zu UBD 160 und 210

UBD 160 210 bis 90mm, mit EBB: bis 270mm

UBD 160 211 bis 165mm, mit EBB: bis 345mm



Trittschall-Unterlage 3mm, für Einbaubox

Set à 4 Stk.

UBD 001 002

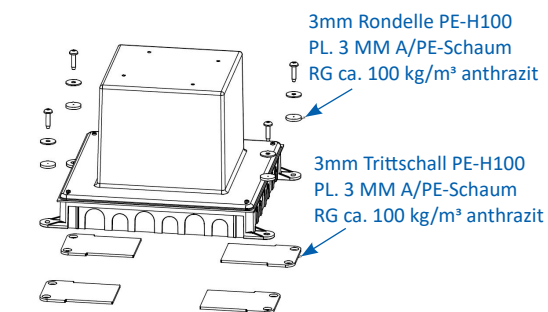
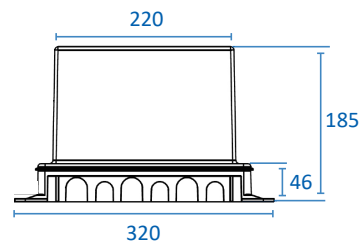

Details UBD 160 210

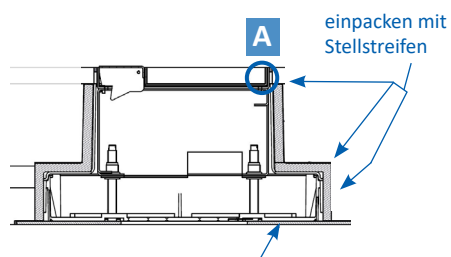
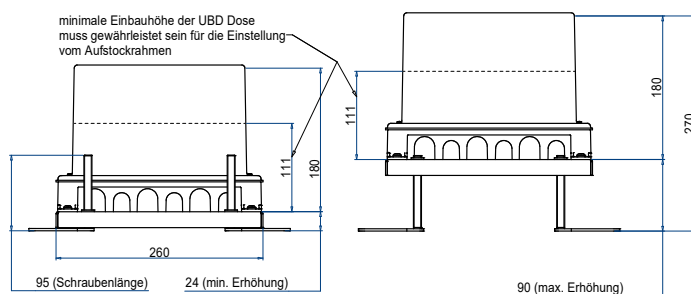

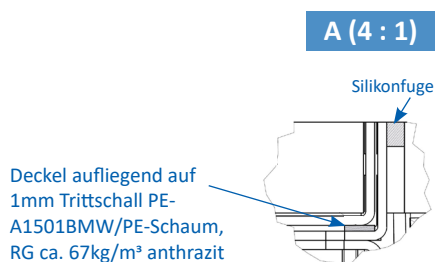
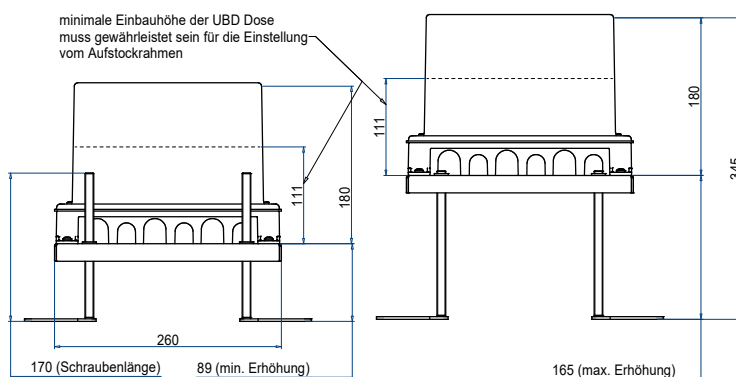

Einbaubox aufliegend auf 3mm Trittschall PE-H100 PL. 3 MM A/PE-Schaum, RG ca. 100 kg/m³ anthrazit

Details UBD 160 211



mit 15mm Vertiefung

	Unterflur-Bodendose UBD 210 aus Chromstahl inkl. Deckel mit Kante, geschlossen, 15mm Vertiefung und 1 Schnurauslass
UBD 210 205	

	Unterflur-Bodendose UBD 210 aus Chromstahl inkl. Deckel mit Kante, geschlossen, 15mm Vertiefung und 1 Bürstenauslass
UBD 210 206	

	Unterflur-Bodendose UBD 210 aus Chromstahl inkl. Blinddeckel mit Kante, geschlossen, und 15mm Vertiefung
UBD 210 209	

	Nivellierschrauben, Set à 4 Stk.
	Nivellierbereich von Roh- bis Fertigboden
UBD 001 070	112 - 159mm
UBD 001 095	128 - 184mm
UBD 001 120	153 - 209mm

Chromstahl geschliffen

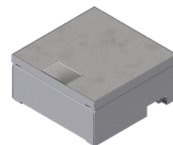
	Unterflur-Bodendose UBD 210 aus Chromstahl inkl. belegtem Deckel und 1 Schnurauslass
UBD 210 207	

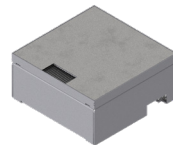
	Unterflur-Bodendose UBD 210 aus Chromstahl inkl. belegtem Deckel und 1 Bürstenauslass
UBD 210 208	

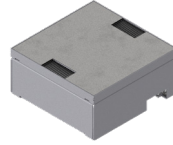
	Unterflur-Bodendose UBD 210 aus Chromstahl inkl. belegtem Deckel und 2 Bürstenauslässen
UBD 210 203	

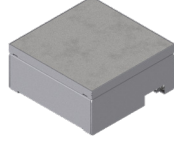
	Unterflur-Bodendose UBD 210 aus Chromstahl inkl. belegtem Blinddeckel
UBD 210 202	

	Nivellierschrauben, Set à 4 Stk.
	Nivellierbereich von Roh- bis Fertigboden
UBD 001 070	112 - 159mm
UBD 001 095	128 - 184mm
UBD 001 120	153 - 209mm





mit 5mm Vertiefung

	Unterflur-Bodendose UBD 210 aus Chromstahl inkl. Deckel, flach (SVZ), ohne Kante, 5mm Vertiefung und 1 Schnurauslass
UBD 212 051	

	Unterflur-Bodendose UBD 210 aus Chromstahl inkl. Deckel, flach (SVZ), ohne Kante, 5mm Vertiefung und 1 Bürstenauslass
UBD 212 052	

mit 20mm Vertiefung

	Unterflur-Bodendose UBD 210 aus Chromstahl inkl. Deckel mit Kante, geschlossen, 20mm Vertiefung und 1 Schnurauslass
UBD 212 201	

	Unterflur-Bodendose UBD 210 aus Chromstahl inkl. Deckel mit Kante, geschlossen, 20mm Vertiefung und 1 Bürstenauslass
UBD 212 202	

	Nivellierschrauben, Set à 4 Stk.
	Nivellierbereich von Roh- bis Fertigboden
UBD 001 070	104 - 151mm
UBD 001 095	120 - 176mm
UBD 001 120	145 - 201mm

	Nivellierschrauben, Set à 4 Stk.
	Nivellierbereich von Roh- bis Fertigboden
UBD 001 070	117 - 164mm
UBD 001 095	133 - 189mm
UBD 001 120	158 - 214mm

mit 25mm Vertiefung

	Unterflur-Bodendose UBD 210 aus Chromstahl inkl. Deckel mit Kante, geschlossen, 25mm Vertiefung und 1 Schnurauslass
UBD 212 251	

	Unterflur-Bodendose UBD 210 aus Chromstahl inkl. Deckel mit Kante, geschlossen, 25mm Vertiefung und 1 Bürstenauslass
UBD 212 252	

mit 30mm Vertiefung

	Unterflur-Bodendose UBD 210 aus Chromstahl inkl. Deckel mit Kante, geschlossen, 30mm Vertiefung und 1 Schnurauslass
UBD 212 301	

	Unterflur-Bodendose UBD 210 aus Chromstahl inkl. Deckel mit Kante, geschlossen, 30mm Vertiefung und 1 Bürstenauslass
UBD 212 302	

	Nivellierschrauben, Set à 4 Stk.
	Nivellierbereich von Roh- bis Fertigboden
UBD 001 045	122 - 169mm
UBD 001 070	138 - 194mm
UBD 001 095	163 - 219mm

	Nivellierschrauben, Set à 4 Stk.
	Nivellierbereich von Roh- bis Fertigboden
UBD 001 045	127 - 174mm
UBD 001 070	143 - 199mm
UBD 001 095	168 - 224mm

Schwerlast-Bodendose

	Schwerlast-Unterflur-Bodendose UBD 210 aus Chromstahl inkl. Deckel mit Kante, geschlossen, 4mm Verstärkungsplatte, 16mm Vertiefung und 1 Schnurauslass
UBD 212 161	

	Schwerlast-Unterflur-Bodendose UBD 210 aus Chromstahl inkl. Deckel mit Kante, geschlossen, 4mm Verstärkungsplatte, 16mm Vertiefung und 1 Bürstenauslass
UBD 212 162	

	Schwerlast-Unterflur-Bodendose UBD 210 aus Chromstahl inkl. belegtem Deckel mit 4mm Verstärkungsplatte und 1 Bürstenauslass
UBD 212 163	

	Nivellierschrauben, Set à 4 Stk.
	Nivellierbereich von Roh- bis Fertigboden
UBD 001 070	117 - 164mm
UBD 001 095	133 - 189mm
UBD 001 120	158 - 214mm

ohne Schutzkante

	Unterflur-Bodendose UBD 210 aus Chromstahl inkl. belegtem Deckel aus 4mm SVZ, ohne Schutzkante, mit Ausschnitt
UBD 212 001	

	Nivellierschrauben, Set à 4 Stk.
	Nivellierbereich von Roh- bis Unterlagsboden
UBD 001 070	99 - 146mm
UBD 001 095	115 - 171mm
UBD 001 120	140 - 196mm



Beispiele Bestückung



3x 1xT13 weiss +
1xT13 schwarz + 2xRJ45 + TV



3xT13/s + 3x 2xRJ45 + blind

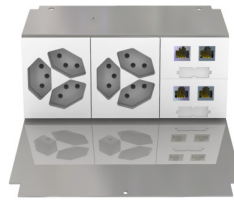

2x 3xT13 + 2x 2xRJ45



3xT13 + 2xRJ45 + TV
+ 2x blind

Steckdoseneinsatz für 6 FLF



Steckdoseneinsatz für 6 FLF inkl.
Erddraht, leer

UBD 210 215

Modul 45x45

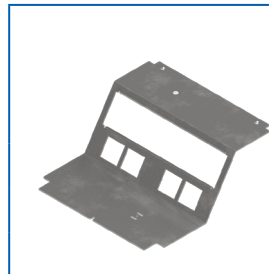



Steckdoseneinsatz mit 4x 45x45-
und 4x MH-Ausschnitten, leer

UBD 210 290

CMD 100 001, MH Blinddeckel

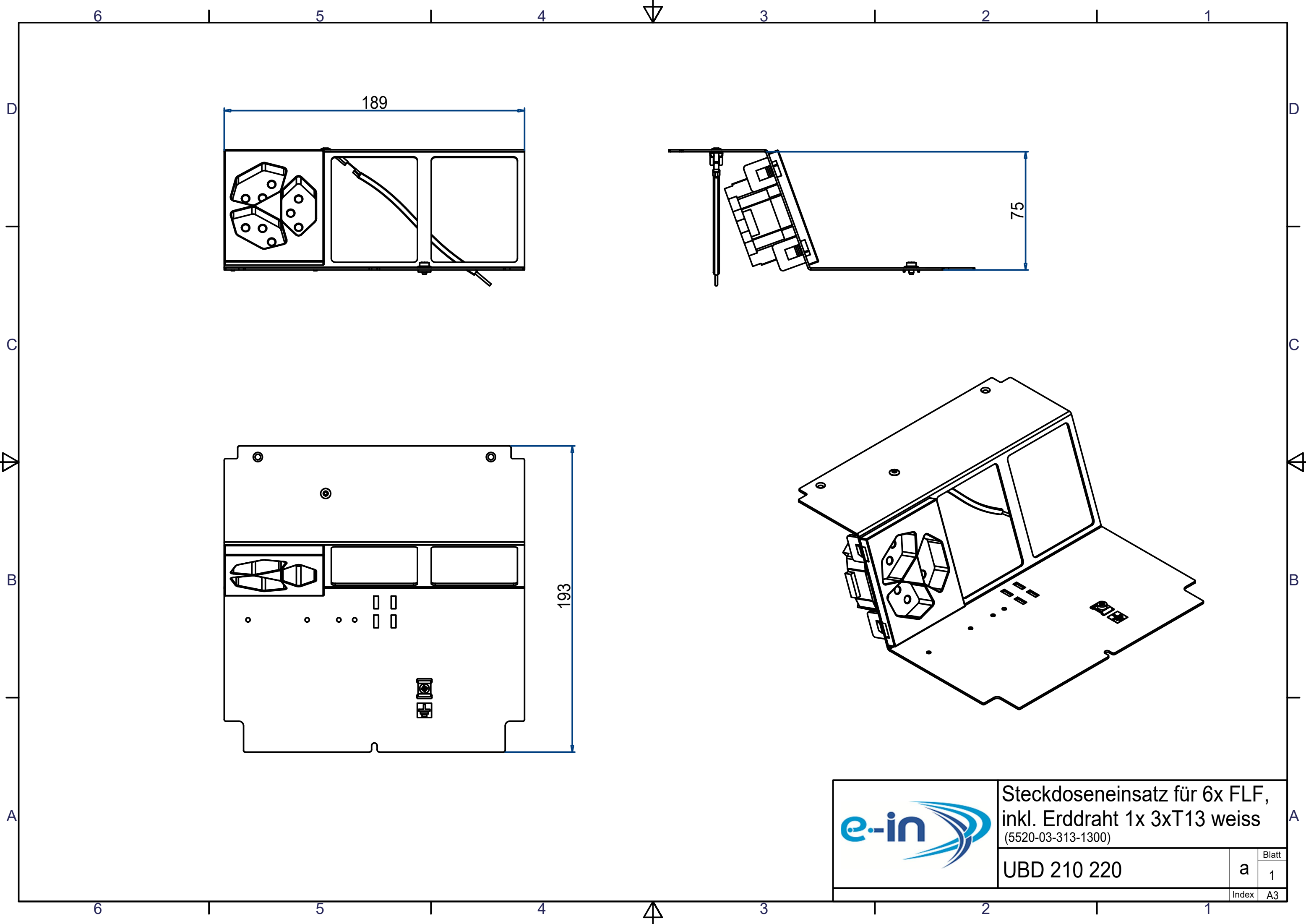
CMD 100 003, MH Keystone



	Steckdoseneinsatz für 6x FLF, inkl. Erddraht 1x 3xT13 weiss (5520-03-313-1300)				
	UBD 210 220	<table border="1"> <tr> <td>Blatt</td> <td>1</td> </tr> <tr> <td>Index</td> <td>A3</td> </tr> </table>	Blatt	1	Index
Blatt	1				
Index	A3				

Unterflur-Bodendose UBD

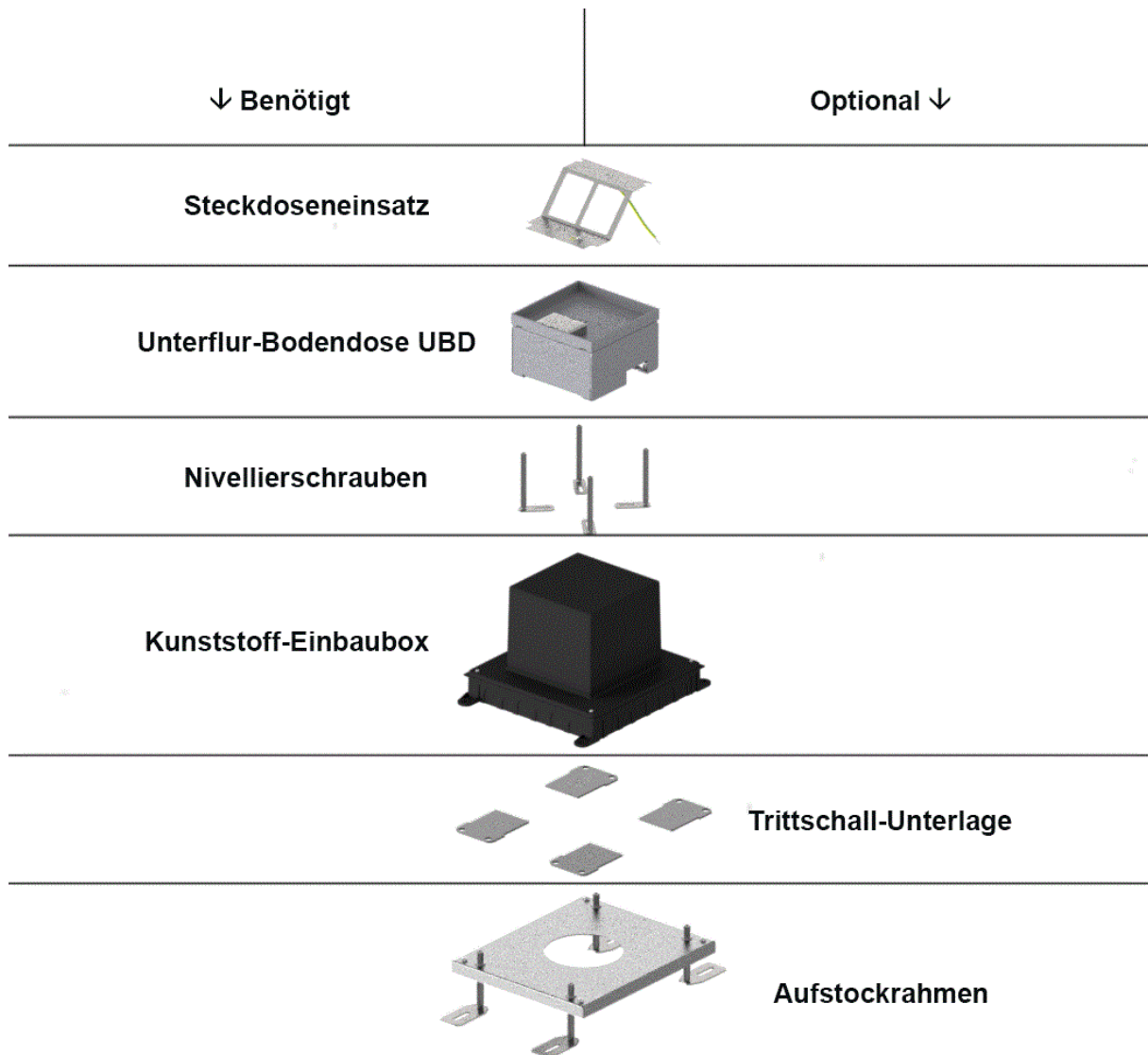

Anmerkung

1. Etappe: Kunststoff-Einbaubox, Trittschall-Unterlage, Aufstockrahmen
2. Etappe: Unterflur-Bodendose UBD, Nivellierschrauben, Steckdoseneinsatz