

## Unterflur-Bodendose UBD 160 small aus Chromstahl

---



- Minimaler Bodenaufbau ab 72mm mit 5mm Vertiefung im Deckel (Isolation + Unterlagsboden + Bodenbelag)
- Mit innenliegenden Nivellierschrauben
- Rahmen, Deckel mit Kante, Auslass und Steckdoseneinsatz aus Chromstahl
- Unterteil, Deckel flach und Nivellierschrauben aus SVZ (sendzimir-verzinkter Stahl)



	<p>Kunststoff-Einbaubox, schwarz, halogenfrei (siehe Datenblatt)          oben: 170/170mm          unten: 260/310mm          H: 185mm</p> <p><b>UBD 160 198</b></p>
---	---

	<p>Trittschall-Unterlage 3mm, für Einbaubox          Set à 4 Stk.</p> <p><b>UBD 001 002</b></p>
---	---

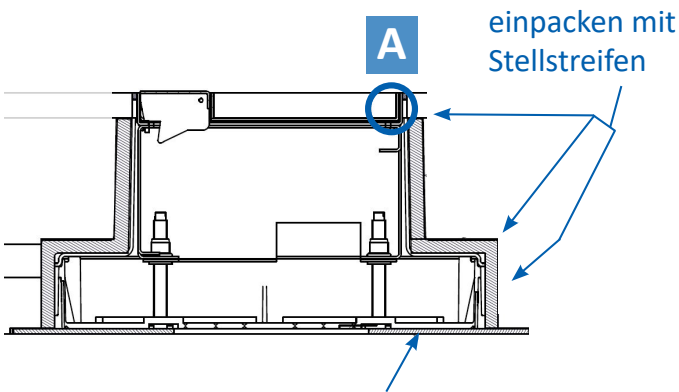
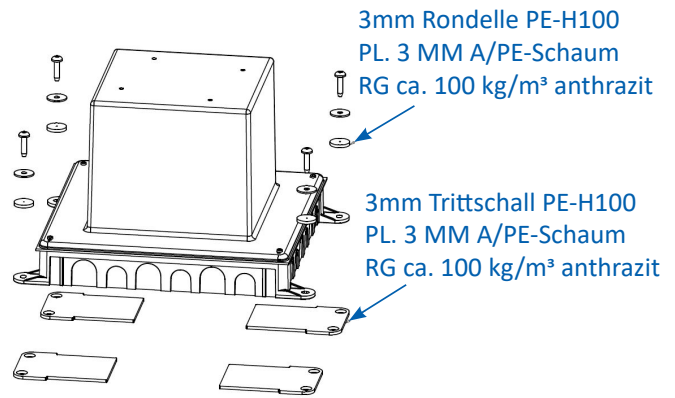
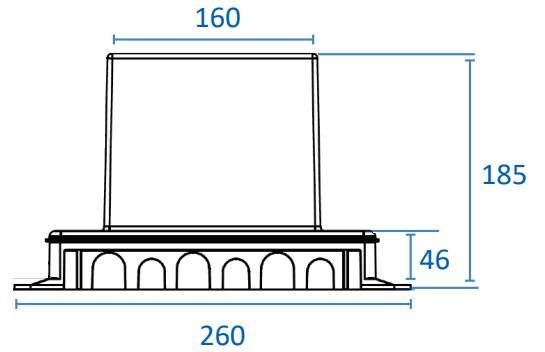

Einbaubox aufliegend auf 3mm Trittschall PE-H100 PL. 3 MM A/PE-Schaum, RG ca. 100 kg/m<sup>3</sup> anthrazit

**A (4 : 1)**

Deckel aufliegend auf 1mm Trittschall PE-A1501BMW/PE-Schaum, RG ca. 67kg/m<sup>3</sup> anthrazit

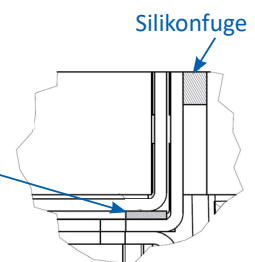

## mit 15mm Vertiefung

	Unterflur-Bodendose UBD 160 small aus Chromstahl inkl. Deckel mit Kante, geschlossen, 15mm Vertiefung und 1 Schnurauslass
<b>UBD 165 155</b>	

	Unterflur-Bodendose UBD 160 small aus Chromstahl inkl. Deckel mit Kante, geschlossen, 15mm Vertiefung und 1 Bürstenauslass
<b>UBD 165 156</b>	

	Unterflur-Bodendose UBD 160 small aus Chromstahl inkl. Blinddeckel mit Kante, geschlossen, und 15mm Vertiefung
<b>UBD 165 159</b>	

	Nivellierschrauben, Set à 4 Stk.
	Nivellierbereich von Roh- bis Fertigboden
<b>UBD 001 045</b>	80 - 102mm
<b>UBD 001 070</b>	103 - 127mm
<b>UBD 001 095</b>	128 - 152mm

## Chromstahl geschliffen

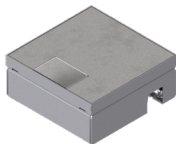
	Unterflur-Bodendose UBD 160 small aus Chromstahl inkl. belegtem Deckel und 1 Schnurauslass
<b>UBD 165 157</b>	

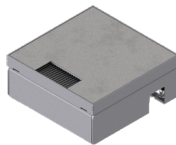
	Unterflur-Bodendose UBD 160 small aus Chromstahl inkl. belegtem Deckel und 1 Bürstenauslass
<b>UBD 165 158</b>	

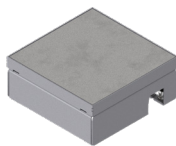
	Unterflur-Bodendose UBD 160 small aus Chromstahl inkl. belegtem Blinddeckel
<b>UBD 165 153</b>	

	Nivellierschrauben, Set à 4 Stk.
	Nivellierbereich von Roh- bis Fertigboden
<b>UBD 001 045</b>	80 - 102mm
<b>UBD 001 070</b>	103 - 127mm
<b>UBD 001 095</b>	128 - 152mm



## mit 5mm Vertiefung

	Unterflur-Bodendose UBD 160 small aus Chromstahl inkl. Deckel, flach (SVZ), ohne Kante, 5mm Vertiefung und 1 Schnurauslass
<b>UBD 167 051</b>	

	Unterflur-Bodendose UBD 160 small aus Chromstahl inkl. Deckel, flach (SVZ), ohne Kante, 5mm Vertiefung und 1 Bürstenauslass
<b>UBD 167 052</b>	

	Nivellierschrauben, Set à 4 Stk.
	Nivellierbereich von Roh- bis Fertigboden
<b>UBD 001 045</b>	72 - 94mm
<b>UBD 001 070</b>	95 - 119mm
<b>UBD 001 095</b>	120 - 144mm

## mit 20mm Vertiefung

	Unterflur-Bodendose UBD 160 small aus Chromstahl inkl. Deckel mit Kante, geschlossen, 20mm Vertiefung und 1 Schnurauslass
<b>UBD 167 201</b>	

	Unterflur-Bodendose UBD 160 small aus Chromstahl inkl. Deckel mit Kante, geschlossen, 20mm Vertiefung und 1 Bürstenauslass
<b>UBD 167 202</b>	

	Nivellierschrauben, Set à 4 Stk.
	Nivellierbereich von Roh- bis Fertigboden
<b>UBD 001 045</b>	85 - 107mm
<b>UBD 001 070</b>	108 - 132mm
<b>UBD 001 095</b>	133 - 157mm

## mit 25mm Vertiefung

	Unterflur-Bodendose UBD 160 small aus Chromstahl inkl. Deckel mit Kante, geschlossen, 25mm Vertiefung und 1 Schnurauslass
<b>UBD 167 251</b>	

	Unterflur-Bodendose UBD 160 small aus Chromstahl inkl. Deckel mit Kante, geschlossen, 25mm Vertiefung und 1 Bürstenauslass
<b>UBD 167 252</b>	

	Nivellierschrauben, Set à 4 Stk.
	Nivellierbereich von Roh- bis Fertigboden
<b>UBD 001 045</b>	90 - 112mm
<b>UBD 001 070</b>	113 - 137mm
<b>UBD 001 095</b>	138 - 162mm

## mit 30mm Vertiefung

	Unterflur-Bodendose UBD 160 small aus Chromstahl inkl. Deckel mit Kante, geschlossen, 30mm Vertiefung und 1 Schnurauslass
<b>UBD 167 301</b>	

	Unterflur-Bodendose UBD 160 small aus Chromstahl inkl. Deckel mit Kante, geschlossen, 30mm Vertiefung und 1 Bürstenauslass
<b>UBD 167 302</b>	

	Nivellierschrauben, Set à 4 Stk.
	Nivellierbereich von Roh- bis Fertigboden
<b>UBD 001 045</b>	95 - 117mm
<b>UBD 001 070</b>	118 - 142mm
<b>UBD 001 095</b>	143 - 167mm

## Schwerlast-Bodendose

	Schwerlast-Unterflur-Bodendose UBD 160 small aus Chromstahl inkl. Deckel mit Kante, geschlossen, 4mm Verstärkungsplatte, 16mm Vertiefung und 1 Schnurauslass
<b>UBD 167 161</b>	

	Schwerlast-Unterflur-Bodendose UBD 160 small aus Chromstahl inkl. Deckel mit Kante, geschlossen, 4mm Verstärkungsplatte, 16mm Vertiefung und 1 Bürstenauslass
<b>UBD 167 162</b>	

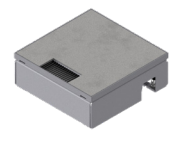
	Schwerlast-Unterflur-Bodendose UBD 160 small aus Chromstahl inkl. belegtem Deckel und 4mm Verstärkungsplatte und 1 Bürstenauslass
<b>UBD 167 163</b>	

	Nivellierschrauben, Set à 4 Stk.
	Nivellierbereich von Roh- bis Fertigboden
<b>UBD 001 070</b>	85 - 107mm
<b>UBD 001 095</b>	108 - 132mm
<b>UBD 001 120</b>	133 - 157mm

## ohne Schutzkante

	Unterflur-Bodendose UBD 160 small aus Chromstahl inkl. belegtem Deckel, ohne Schutzkante mit Ausschnitt aus 4mm SVZ
<b>UBD 167 001</b>	

	Nivellierschrauben, Set à 4 Stk.
	Nivellierbereich von Roh- bis Unterlagsboden
<b>UBD 001 070</b>	67 - 89mm
<b>UBD 001 095</b>	90 - 114mm
<b>UBD 001 120</b>	115 - 139mm

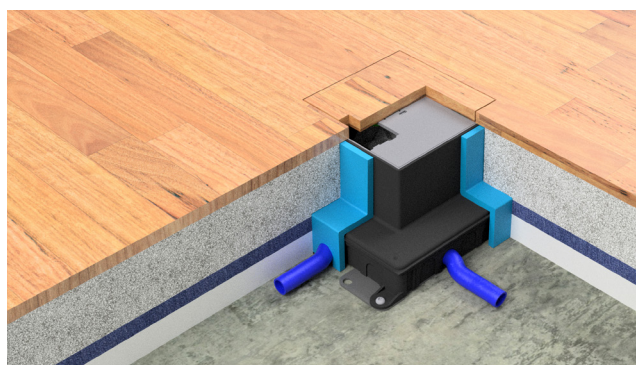
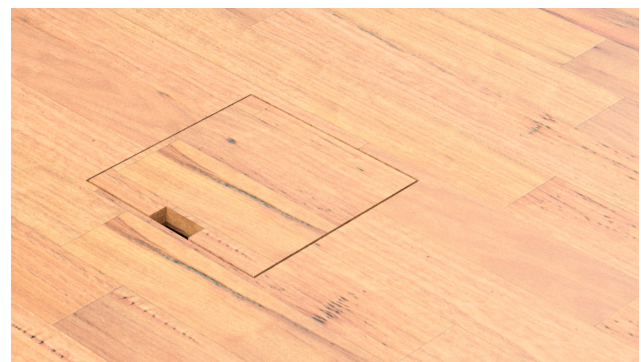

## Beispiele Bestückung



1xT13 + 2xRJ45



4xT13



1xT13 + TV



1xT13 weiss + 1xT13 schwarz

## Steckdoseneinsatz für 2 FLF

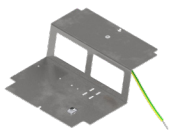

Steckdoseneinsatz für 2 FLF inkl.  
Erddraht, leer

UBD 165 175

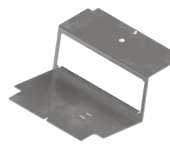

Steckdoseneinsatz mit 3x 45x45-  
Ausschnitten, leer

UBD 165 185

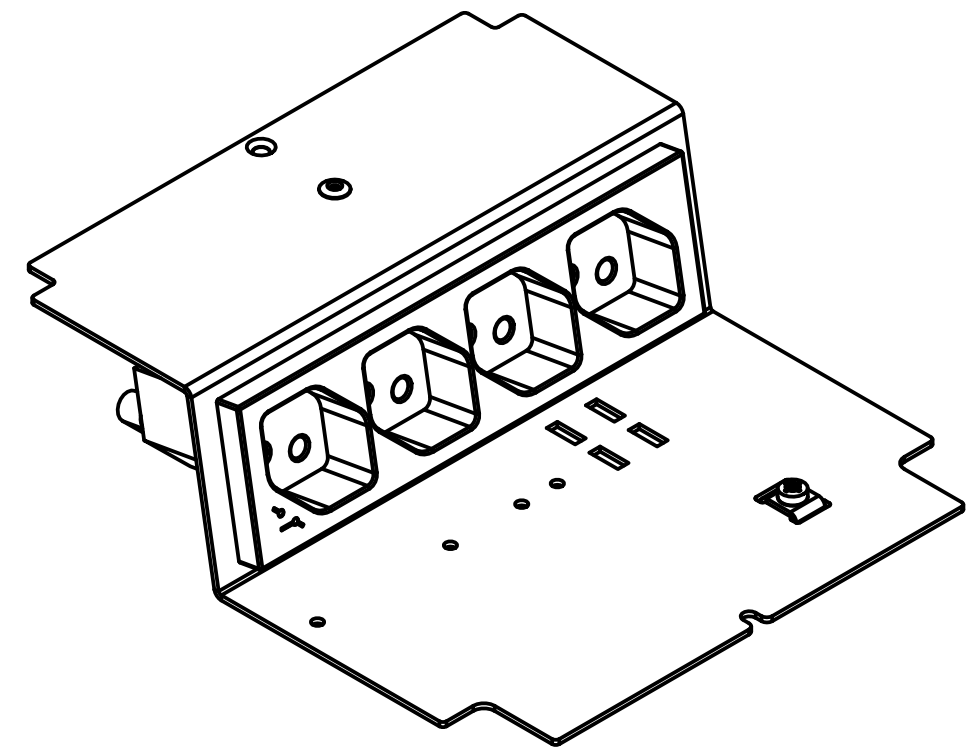
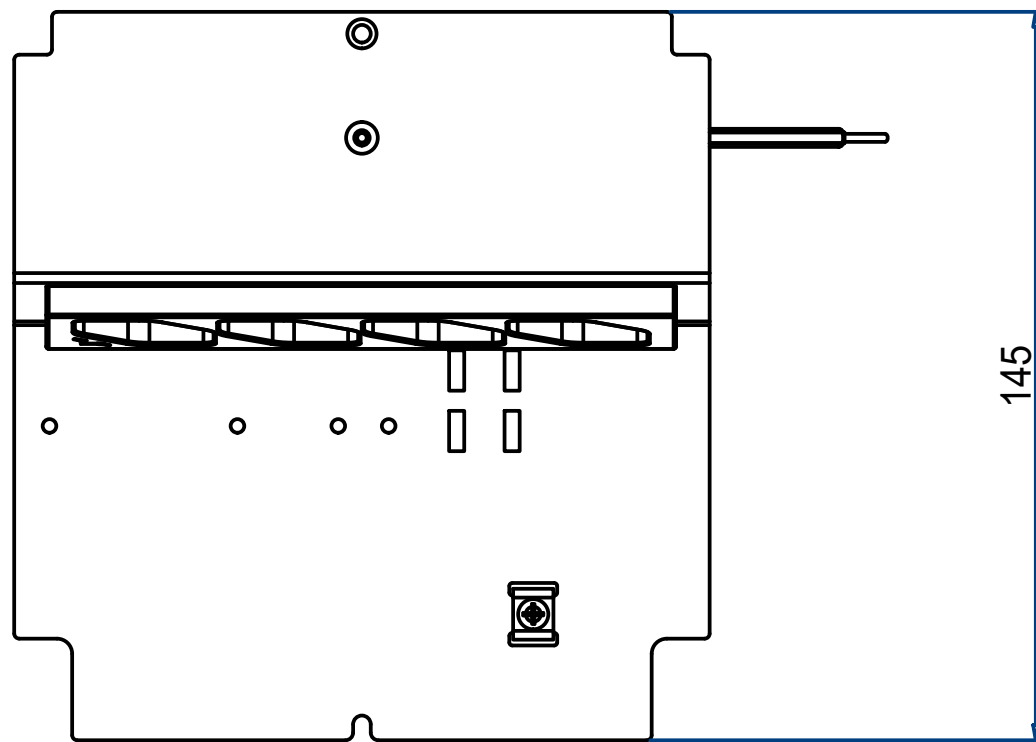
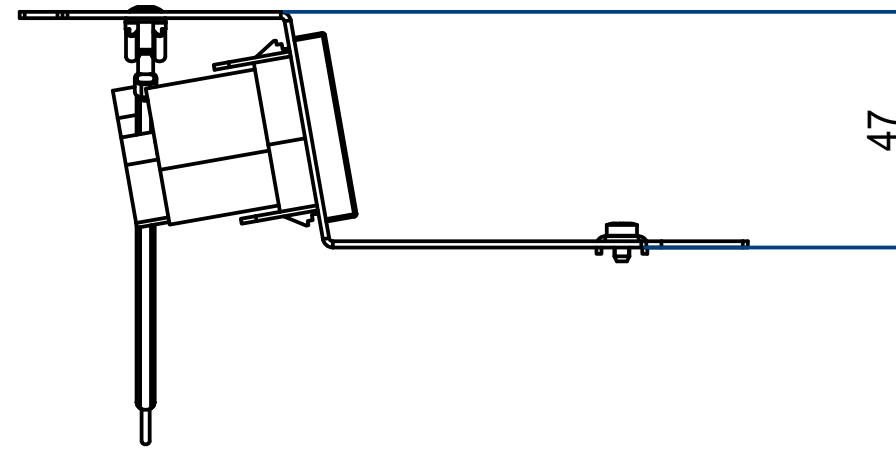
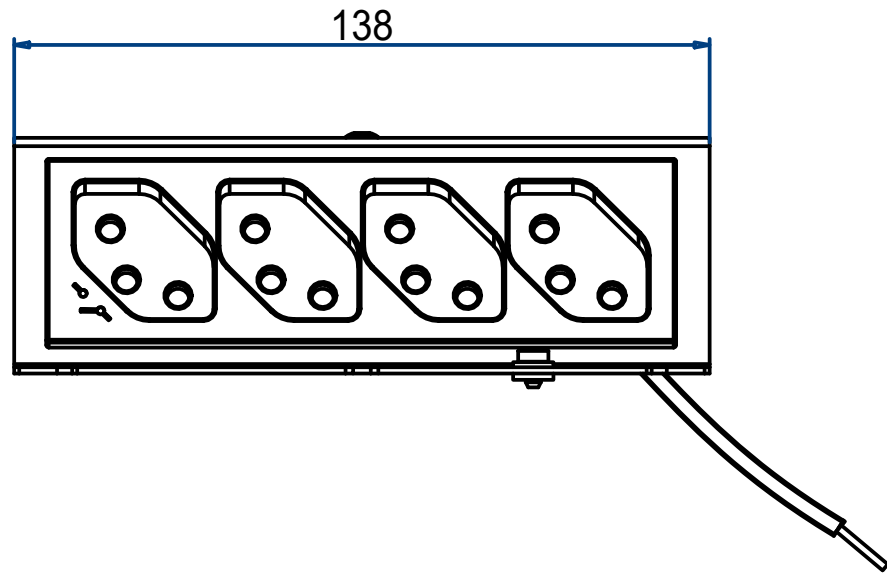

Steckdoseneinsatz für 2x FLF,  
inkl. Erddraht 1x 4xT13/s weiss  
(5520-09-041-500-KZ)

UBD 165 180

Blatt	1
Index	A3

a

## Unterflur-Bodendose UBD

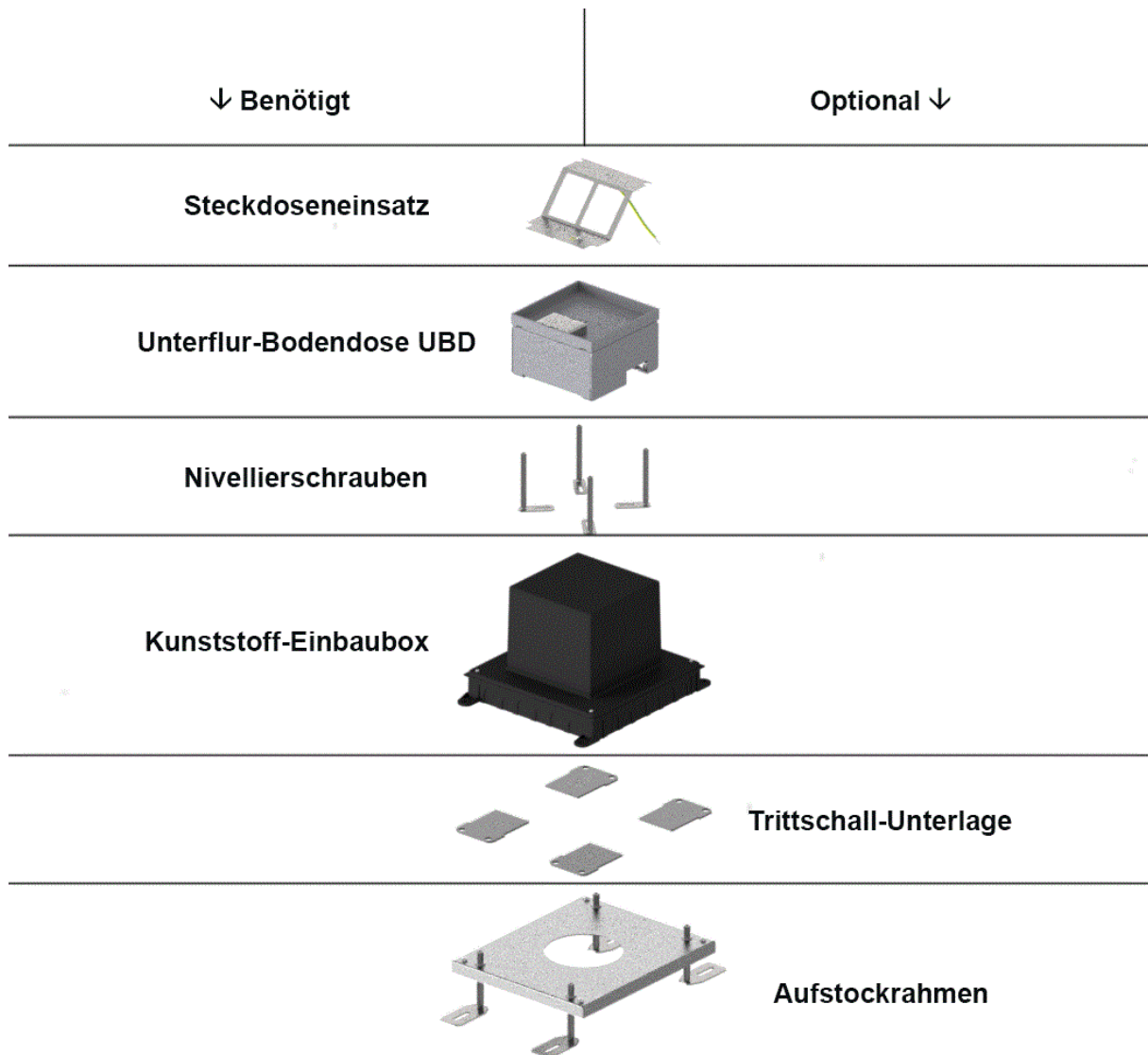

### Anmerkung

1. Etappe: Kunststoff-Einbaubox, Trittschall-Unterlage, Aufstockrahmen
2. Etappe: Unterflur-Bodendose UBD, Nivellierschrauben, Steckdoseneinsatz