

Unterflur-Bodendose UBD 160 small aus Chromstahl



- Minimaler Bodenaufbau ab 72mm mit 5mm Vertiefung im Deckel (Isolation + Unterlagsboden + Bodenbelag)
- Mit innenliegenden Nivellierschrauben
- Rahmen, Deckel mit Kante, Auslass und Steckdoseneinsatz aus Chromstahl
- Unterteil, Deckel flach und Nivellierschrauben aus SVZ (sendzimir-verzinkter Stahl)



	<p>Kunststoff-Einbaubox, schwarz, halogenfrei (siehe Datenblatt) oben: 170/170mm unten: 260/310mm H: 185mm</p> <p>UBD 160 198</p>
---	---

	<p>Trittschall-Unterlage 3mm, für Einbaubox Set à 4 Stk.</p> <p>UBD 001 002</p>
---	---

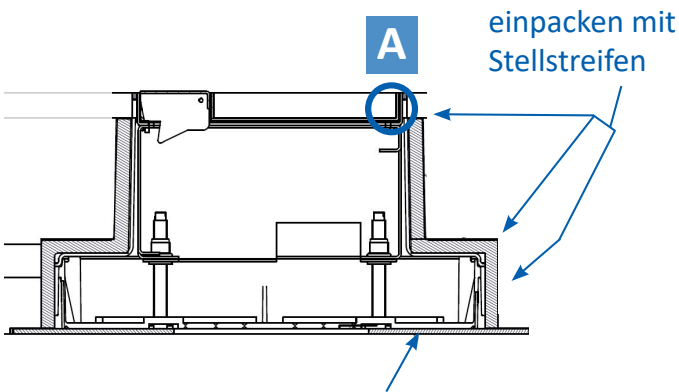
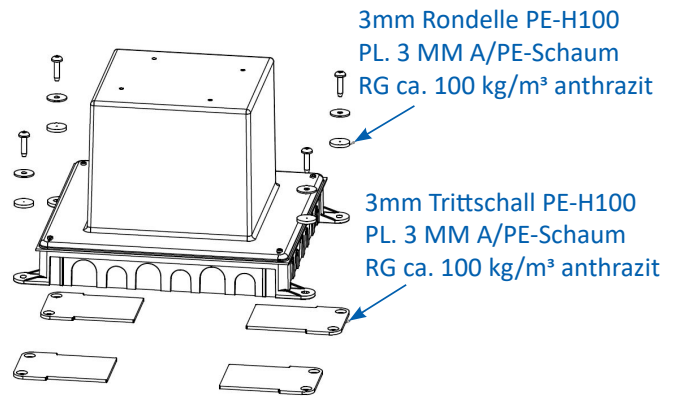
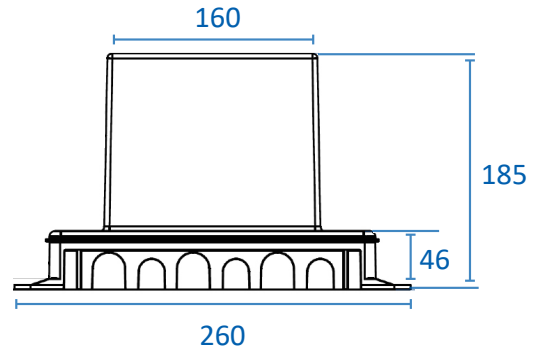

Einbaubox aufliegend auf 3mm Trittschall PE-H100 PL. 3 MM A/PE-Schaum, RG ca. 100 kg/m³ anthrazit

A (4 : 1)

Deckel aufliegend auf 1mm Trittschall PE-A1501BMW/PE-Schaum, RG ca. 67kg/m³ anthrazit

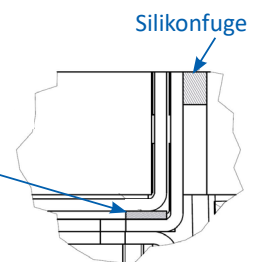

mit 15mm Vertiefung

	Unterflur-Bodendose UBD 160 small aus Chromstahl inkl. Deckel mit Kante, geschlossen, 15mm Vertiefung und 1 Schnurauslass
UBD 165 155	

	Unterflur-Bodendose UBD 160 small aus Chromstahl inkl. Deckel mit Kante, geschlossen, 15mm Vertiefung und 1 Bürstenauslass
UBD 165 156	

	Unterflur-Bodendose UBD 160 small aus Chromstahl inkl. Blinddeckel mit Kante, geschlossen, und 15mm Vertiefung
UBD 165 159	

	Nivellierschrauben, Set à 4 Stk.
	Nivellierbereich von Roh- bis Fertigboden
UBD 001 045	80 - 102mm
UBD 001 070	103 - 127mm
UBD 001 095	128 - 152mm

Chromstahl geschliffen

	Unterflur-Bodendose UBD 160 small aus Chromstahl inkl. belegtem Deckel und 1 Schnurauslass
UBD 165 157	

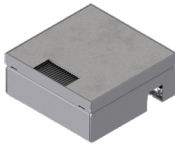
	Unterflur-Bodendose UBD 160 small aus Chromstahl inkl. belegtem Deckel und 1 Bürstenauslass
UBD 165 158	

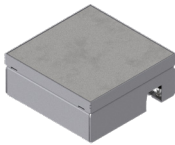
	Unterflur-Bodendose UBD 160 small aus Chromstahl inkl. belegtem Blinddeckel
UBD 165 153	

	Nivellierschrauben, Set à 4 Stk.
	Nivellierbereich von Roh- bis Fertigboden
UBD 001 045	80 - 102mm
UBD 001 070	103 - 127mm
UBD 001 095	128 - 152mm



mit 5mm Vertiefung

	Unterflur-Bodendose UBD 160 small aus Chromstahl inkl. Deckel, flach (SVZ), ohne Kante, 5mm Vertiefung und 1 Schnurauslass
UBD 167 051	

	Unterflur-Bodendose UBD 160 small aus Chromstahl inkl. Deckel, flach (SVZ), ohne Kante, 5mm Vertiefung und 1 Bürstenauslass
UBD 167 052	

	Nivellierschrauben, Set à 4 Stk.
	Nivellierbereich von Roh- bis Fertigboden
UBD 001 045	72 - 94mm
UBD 001 070	95 - 119mm
UBD 001 095	120 - 144mm

mit 20mm Vertiefung

	Unterflur-Bodendose UBD 160 small aus Chromstahl inkl. Deckel mit Kante, geschlossen, 20mm Vertiefung und 1 Schnurauslass
UBD 167 201	

	Unterflur-Bodendose UBD 160 small aus Chromstahl inkl. Deckel mit Kante, geschlossen, 20mm Vertiefung und 1 Bürstenauslass
UBD 167 202	

	Nivellierschrauben, Set à 4 Stk.
	Nivellierbereich von Roh- bis Fertigboden
UBD 001 045	85 - 107mm
UBD 001 070	108 - 132mm
UBD 001 095	133 - 157mm

mit 25mm Vertiefung

	Unterflur-Bodendose UBD 160 small aus Chromstahl inkl. Deckel mit Kante, geschlossen, 25mm Vertiefung und 1 Schnurauslass
UBD 167 251	

	Unterflur-Bodendose UBD 160 small aus Chromstahl inkl. Deckel mit Kante, geschlossen, 25mm Vertiefung und 1 Bürstenauslass
UBD 167 252	

	Nivellierschrauben, Set à 4 Stk.
	Nivellierbereich von Roh- bis Fertigboden
UBD 001 045	90 - 112mm
UBD 001 070	113 - 137mm
UBD 001 095	138 - 162mm

mit 30mm Vertiefung

	Unterflur-Bodendose UBD 160 small aus Chromstahl inkl. Deckel mit Kante, geschlossen, 30mm Vertiefung und 1 Schnurauslass
UBD 167 301	

	Unterflur-Bodendose UBD 160 small aus Chromstahl inkl. Deckel mit Kante, geschlossen, 30mm Vertiefung und 1 Bürstenauslass
UBD 167 302	

	Nivellierschrauben, Set à 4 Stk.
	Nivellierbereich von Roh- bis Fertigboden
UBD 001 045	95 - 117mm
UBD 001 070	118 - 142mm
UBD 001 095	143 - 167mm

Schwerlast-Bodendose

	Schwerlast-Unterflur-Bodendose UBD 160 small aus Chromstahl inkl. Deckel mit Kante, geschlossen, 4mm Verstärkungsplatte, 16mm Vertiefung und 1 Schnurauslass
UBD 167 161	

	Schwerlast-Unterflur-Bodendose UBD 160 small aus Chromstahl inkl. Deckel mit Kante, geschlossen, 4mm Verstärkungsplatte, 16mm Vertiefung und 1 Bürstenauslass
UBD 167 162	

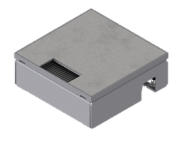
	Schwerlast-Unterflur-Bodendose UBD 160 small aus Chromstahl inkl. belegtem Deckel und 4mm Verstärkungsplatte und 1 Bürstenauslass
UBD 167 163	

	Nivellierschrauben, Set à 4 Stk.
	Nivellierbereich von Roh- bis Fertigboden
UBD 001 070	85 - 107mm
UBD 001 095	108 - 132mm
UBD 001 120	133 - 157mm

ohne Schutzkante

	Unterflur-Bodendose UBD 160 small aus Chromstahl inkl. belegtem Deckel, ohne Schutzkante mit Ausschnitt aus 4mm SVZ
UBD 167 001	

	Nivellierschrauben, Set à 4 Stk.
	Nivellierbereich von Roh- bis Unterlagsboden
UBD 001 070	67 - 89mm
UBD 001 095	90 - 114mm
UBD 001 120	115 - 139mm

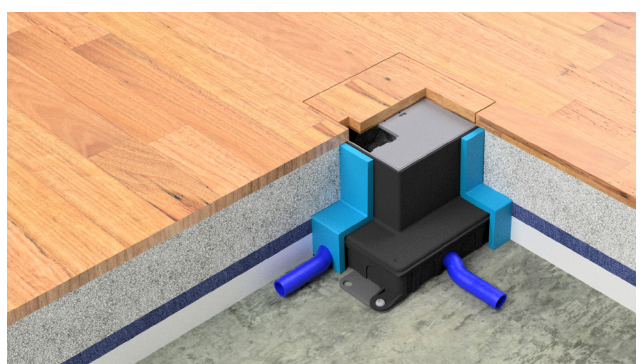
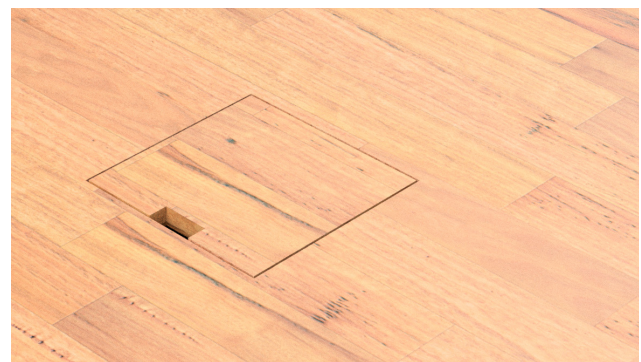

Beispiele Bestückung



1xT13 + 2xRJ45



4xT13



1xT13 + TV



1xT13 weiss + 1xT13 schwarz

Steckdoseneinsatz für 2 FLF

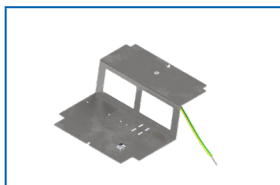

Steckdoseneinsatz für 2 FLF inkl. Erddraht, leer

UBD 165 175



Steckdoseneinsatz mit 3x 45x45-Ausschnitten, leer

UBD 165 185

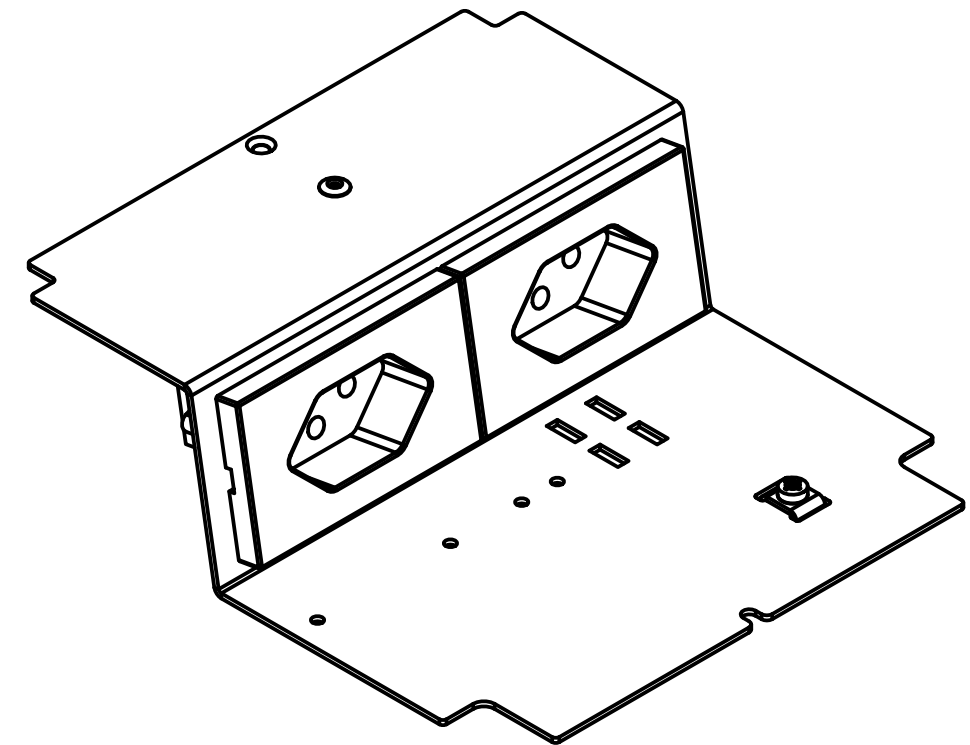
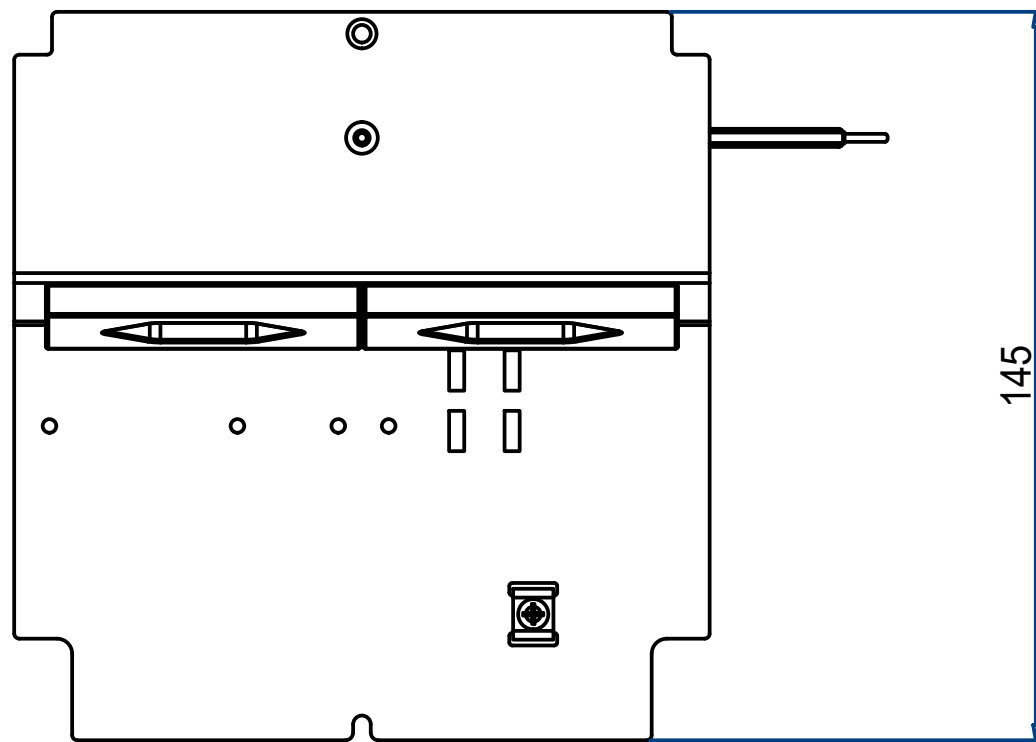
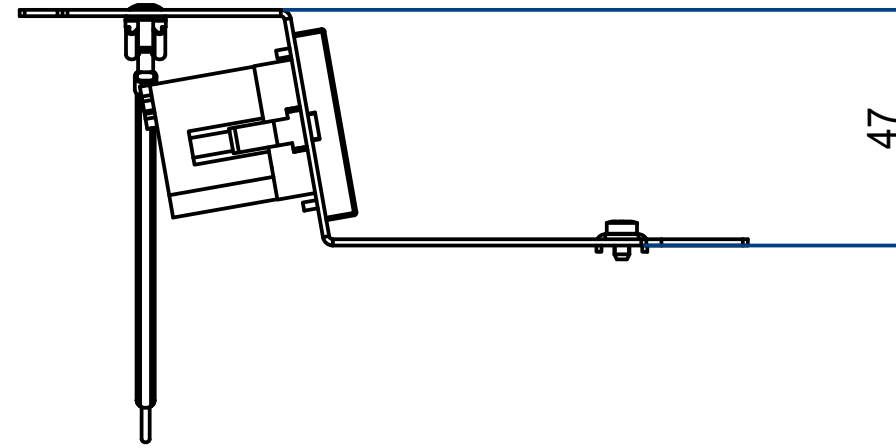
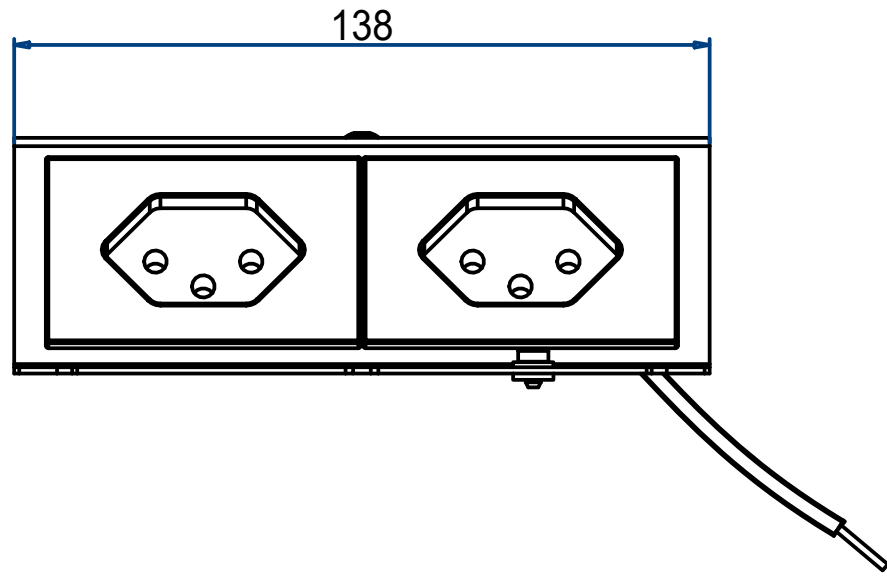

Steckdoseneinsatz für 2x FLF,
inkl. Erddraht 2xT13 weiss
(5520-09-041-200-KZ)

UBD 165 177

Blatt	1
Index	A3

a

Unterflur-Bodendose UBD

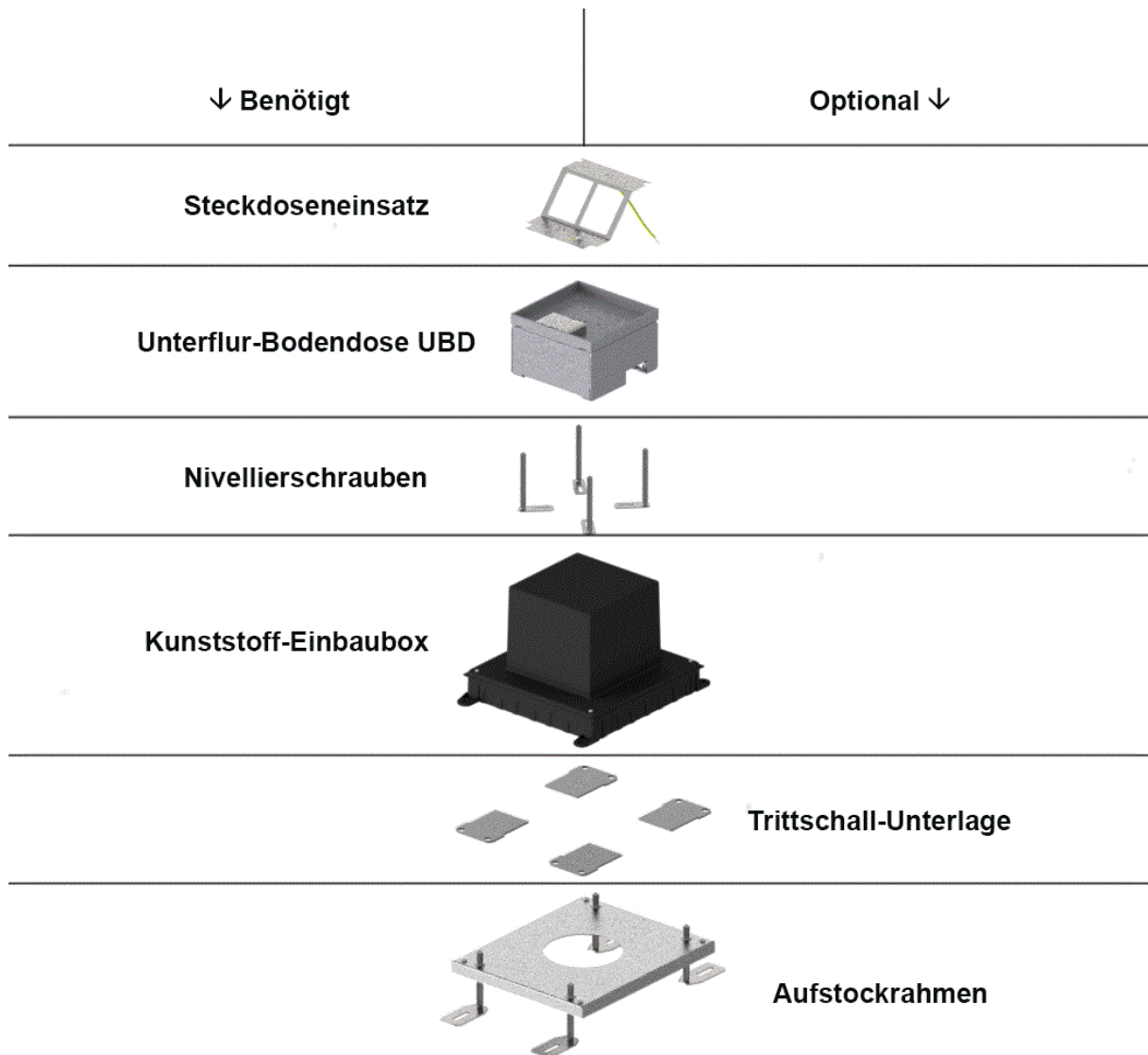

Anmerkung

1. Etappe: Kunststoff-Einbaubox, Trittschall-Unterlage, Aufstockrahmen
2. Etappe: Unterflur-Bodendose UBD, Nivellierschrauben, Steckdoseneinsatz